

# SELF-DUMPING STEEL HOPPER W/ BUMPER RELEASE - D-50-LD

APPROX WEIGHT: 364.76 lbs.

DOES NOT INCLUDE WEIGHT OF POWER OR PACKAGING!!!

\*\*\* ANY ADDITIONS, DELETIONS, OR OMISSIONS MUST BE CORRECTED ON THIS DRAWING AS THIS DRAWING WILL BE CONSIDERED ALL INCLUSIVE \*\*\*

ALL GRAPHICS PROVIDED ARE FOR REFERENCE ONLY. IF CERTAIN DIMENSIONS ARE CRITICAL PLEASE VERIFY THOSE DIMENSIONS WITH YOUR SALESPERSON

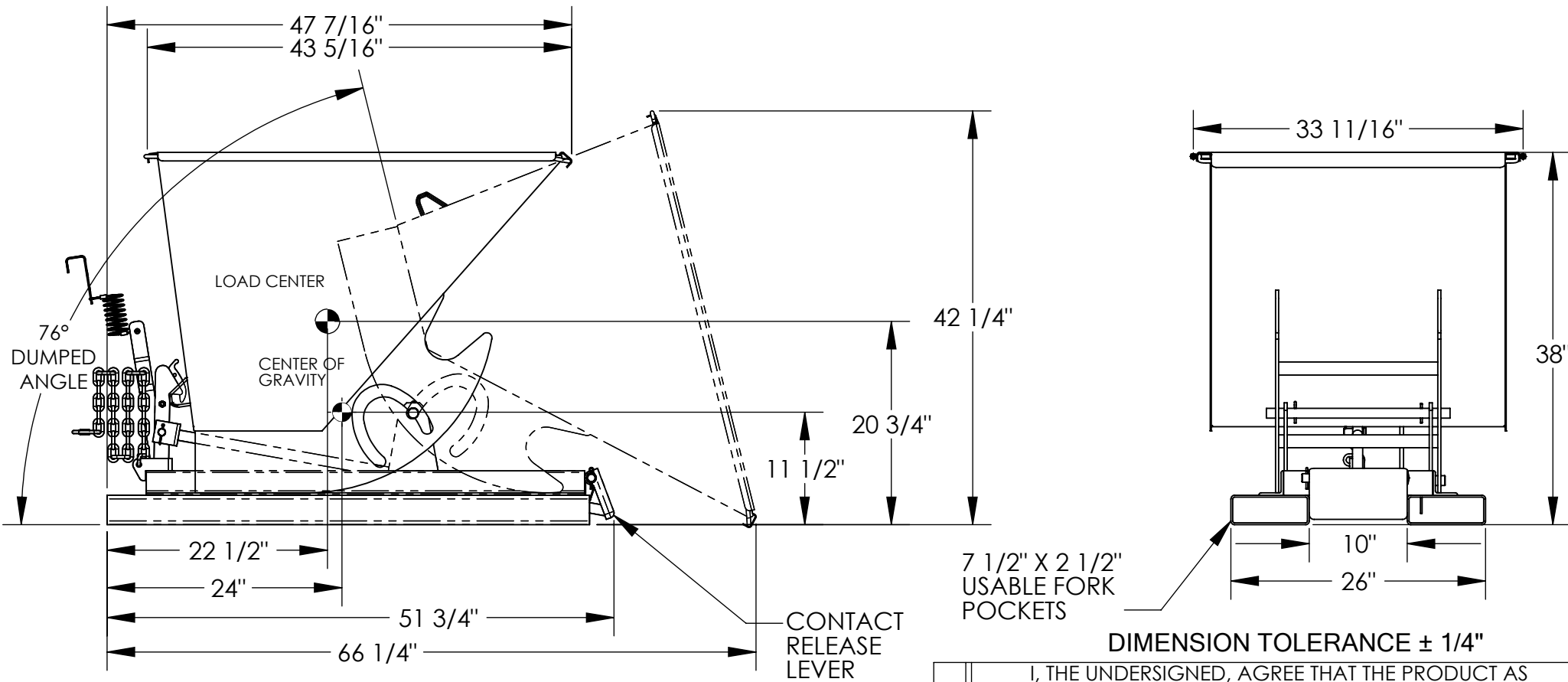

DIMENSION TOLERANCE ± 1/4"

## STANDARD FEATURES

- MODEL NUMBER: D-50-LD
- VOLUME: 1/2 CU. YDS.
- CAPACITY: 2,000 LBS.
- OVERALL WIDTH: 33 11/16"
- OVERALL LENGTH: 51 3/4"
- OVERALL HEIGHT: 38"
- PULL CABLE IS AT LEAST: 48"
- TOUGH BAKED IN POWDER COATED BLUE FINISH

NEVER EXCEED LOAD CENTER RATING PER FORK TRUCK MANUFACTURER'S GUIDELINES. DO NOT USE THIS FORK TRUCK ATTACHMENT IF LOAD WILL EXCEED FORK TRUCK MANUFACTURER'S LOAD CENTER RATING. APPROX. WEIGHT/ LOST LOAD=364.76 LBS. MINIMUM EFFECTIVE THICKNESS= LESS THAN 1"

## SPECIAL FEATURES

NONE

\*\*\* ADDITION OF CASTERS MAY CHANGE WEIGHT CAPACITY BASED ON CASTER RATING \*\*\*

**APPROVAL**

I, THE UNDERSIGNED, AGREE THAT THE PRODUCT AS REPRESENTED SATISFIES DESIGN AND DIMENSION REQUIREMENTS. I ALSO ACKNOWLEDGE MY DUTY TO CONFIRM PRODUCT AND INSTALLATION COMPLIANCE WITH ALL APPLICABLE FEDERAL, STATE AND LOCAL REGULATIONS AND STANDARDS.

**ANY MODIFIED UNITS ARE NON-RETURNABLE**

As drawn       As marked

Signed: \_\_\_\_\_ Date: \_\_\_\_\_

Printed Name: \_\_\_\_\_

LEAD TIME WILL START UPON RECEIPT OF SIGNED APPROVAL DRAWING

FOR INTERNAL USE ONLY PROJECT SIGN OFF	
SALES	
ENG.	
FAB.	
POWER	

DISTRIBUTOR'S NAME:		P.O.#
VESTIL MANUFACTURING		X
W.O.#		X
DRAWN BY: W. STALEY	DATE: 5/7/08	SALES: X
REFERENCE: X	SCALE: 1:15	FILE NAME:
QUOTED LEAD TIME: X	QUOTE # X	37-007-049